



Panasonic KX-HDV130
User Guide

Contents

Installation	3
Desk Setup	3
Wall Mounting.....	4
Location of Controls	6
Provisioning Instructions.....	7
NextOS 3.0 Beta Portal	7
Checking the Firmware	9
Entering the Provisioning Server	12
Additional Setup Options.....	15
Correcting the Time	15
Line Mirroring.....	17
Busy Lamp Field (BLF)	17
Directories	18
Speed Dials	18
Automatic Call Distribution (ACD) States.....	22
Basic Phone Usage	23
Making a Call	23
Making a Second Call	24
Accepting a Call	25
Accepting a Second Call	25
Terminating a Call	26
Transferring a Call	26
Conferencing	27
Checking Voicemail	27
Directories	28
Call Lists.....	28
Changing ACD States.....	29
Using Speed Dials	31
Additional Features	32
Do Not Disturb (DND)	32
Factory Reset	33

Installation

Desk Setup

1. Attach the stand by inserting the stand into the slots as shown below (*Figure 1-1*).

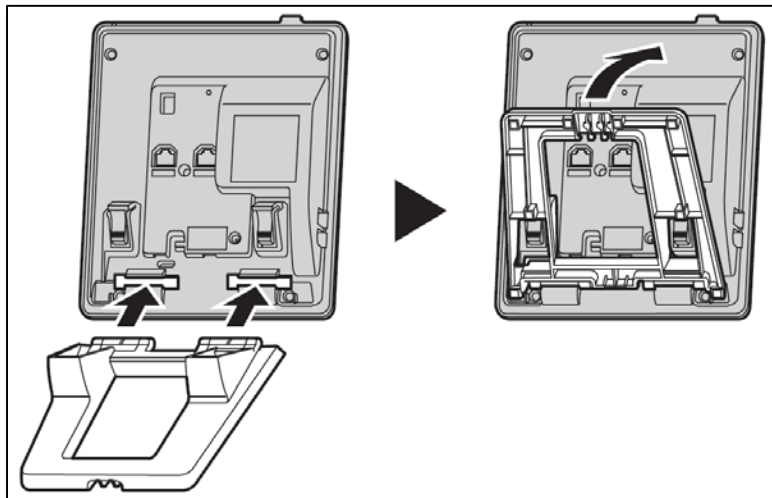

Figure 1-1: Attaching the Stand

2. Connect the Ethernet cable, the handset and the AC adapter as shown below. If desired, an optional headset or computer pass-through can also be connected to the phone (*Figure 1-2*).

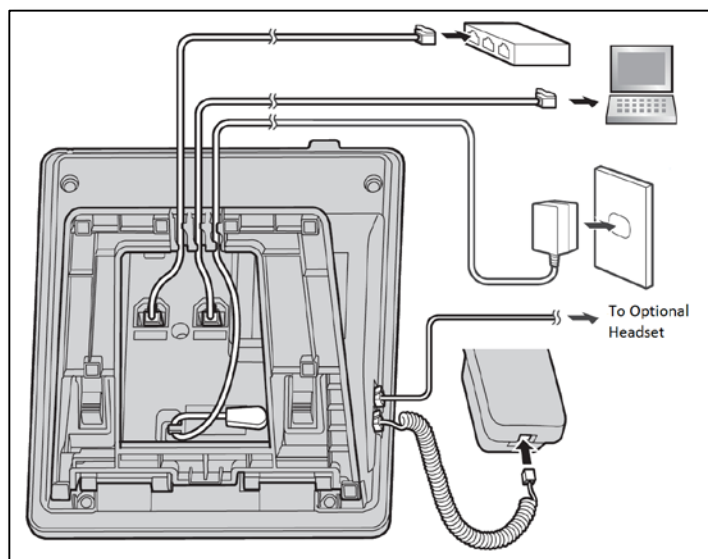

Figure 1-2: Attaching the Cables

Wall Mounting

Before attempting to mount the Panasonic KX-HDV130 phone to a wall, make sure the wall and the attachment method is strong enough to support the weight of the phone.

Insert the tabs of the wall mounting adapter in to the designated openings in the base, and then slide the wall mounting adapter in the direction of the arrow until it clicks (*Figure 1-3*).

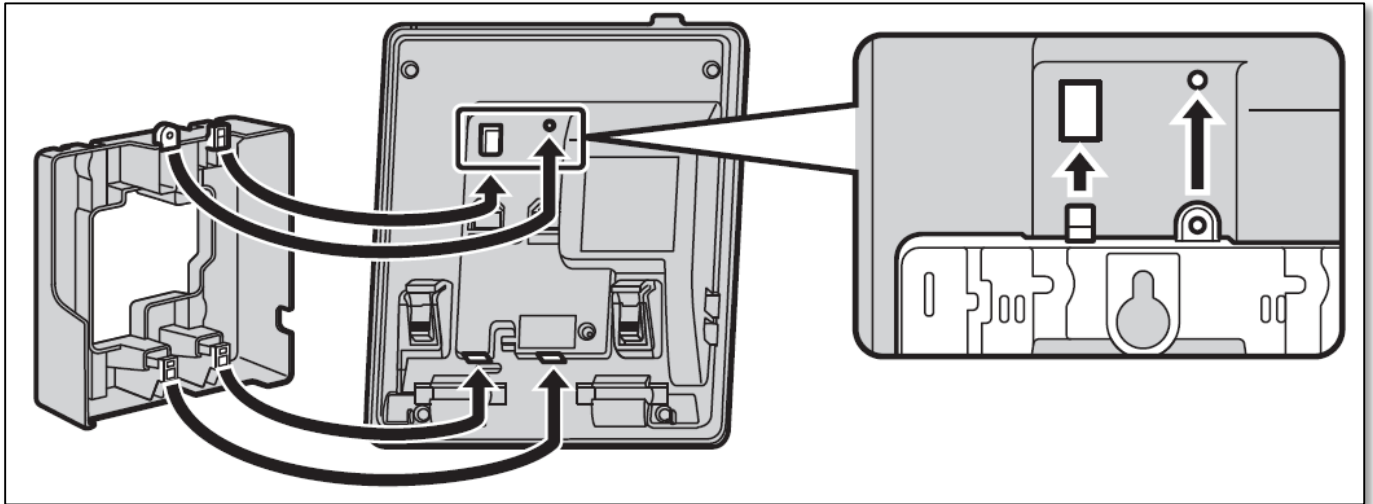

Figure 1-3: Wall Mount Plate

Once you have connected the Wall Mount Plate to the phone via the tabs, follow the steps below (Figure 1-4):

1. Fasten the wall mounting adapter to the base with the small screw.
2. Connect the AC adapter and handset cord.
3. Drive the large screws into the wall either 3 ¼ inches apart or 3 15/16 inches apart, and mount the unit to the wall.

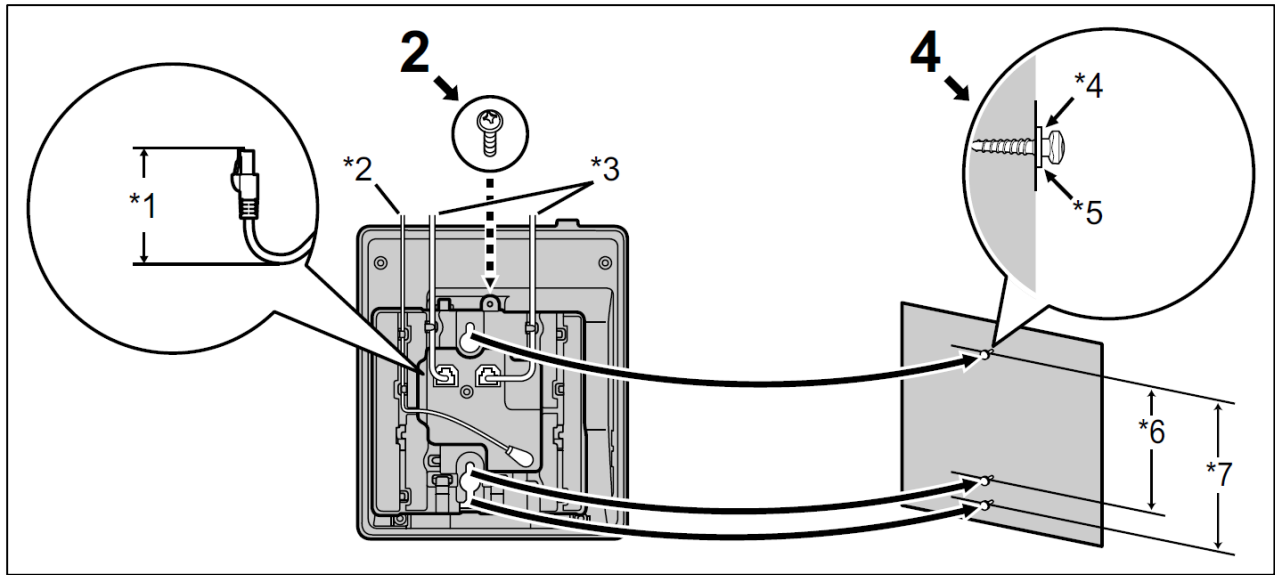

Figure 1-4: Attaching to the Wall

- *1 – 1 37/64 inches or less
- *2 – AC Adapter
- *3 – Ethernet cables
- *4 – Washer
- *5 – Drive the screw to this point
- *6 – 3 ¼ inches
- *7 – 3 15/16 inches apart

Location of Controls

The image below shows the standard buttons on the Panasonic KX-HDV130 (Figure 2-1).

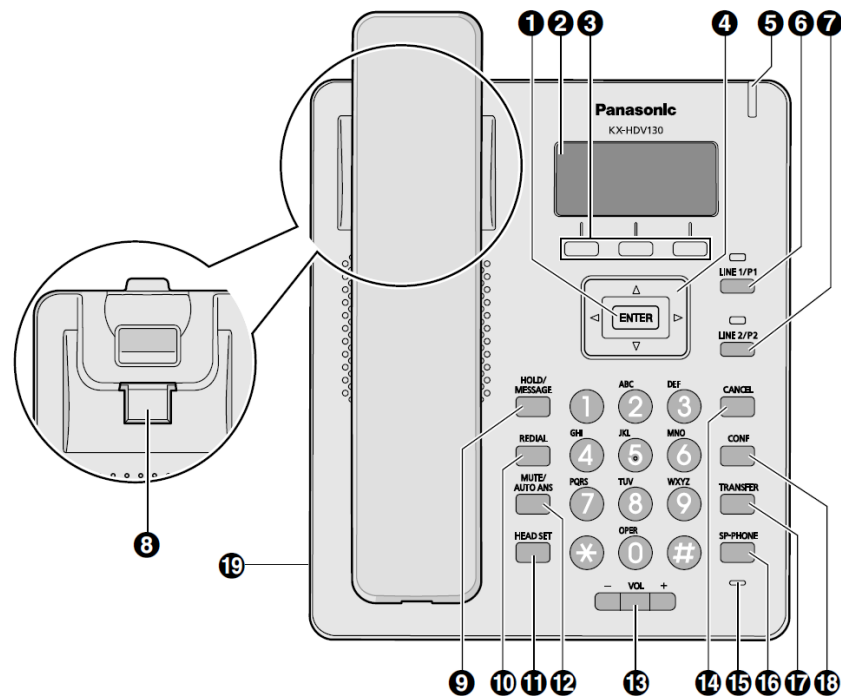

Figure 2-1: Button Map

Figure 2-1 Key

- | | |
|-------------------------------------------------|-----------------------------|
| 1. ENTER – used to confirm a selected item. | 10. REDIAL |
| 2. LCD (Liquid Crystal Display) | 11. HEADSET |
| 3. Softkeys | 12. MUTE/AUTO ANS |
| 4. Navigator key | 13. VOL (volume) |
| 5. Ringer/message waiting/missed call indicator | 14. CANCEL |
| 6. Line/program key 1 | 15. Microphone |
| 7. Line/program key 2 | 16. SP-PHONE (speakerphone) |
| 8. Handset hook | 17. TRANSFER |
| 9. HOLD/MESSAGE | 18. CONF (conference) |
| | 19. Headset jack |

Provisioning Instructions

Before you can make calls with the Panasonic KX-HDV130, it must be added to your Nextiva account, assigned to a user, and provisioned.

NextOS 3.0 Beta Portal

1. For Administrators, log in to the NextOS 3.0 Beta portal by visiting www.nextiva.com and clicking on the customer Login found at the top right.
2. Log in to the NextOS 3.0 Beta portal with your login credentials.
3. From the main dashboard, click **Manage** in the **Users** tile.

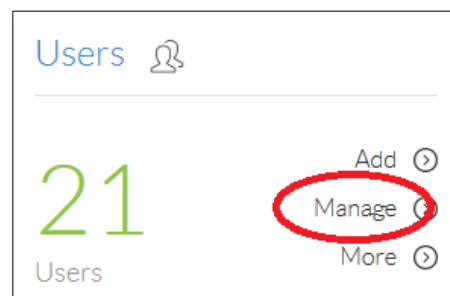

Figure 3-1: Users Tile

4. Hover your cursor over the user to whom you are assigning a device, and click the **pencil icon** that appears to the right of their name (Figure 3-2).

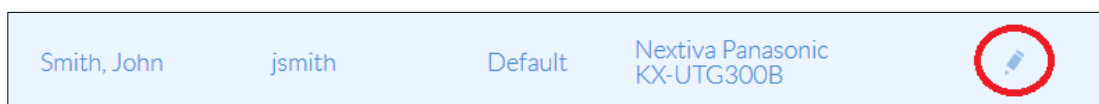

Figure 3-2: Edit User

5. Scroll down, and click the **Devices** section.
6. Select the **Own Device** radio button.

7. Select the Panasonic KX-HDV130 phone from the drop-down list below the Own Device radio button (Figure 3-3).

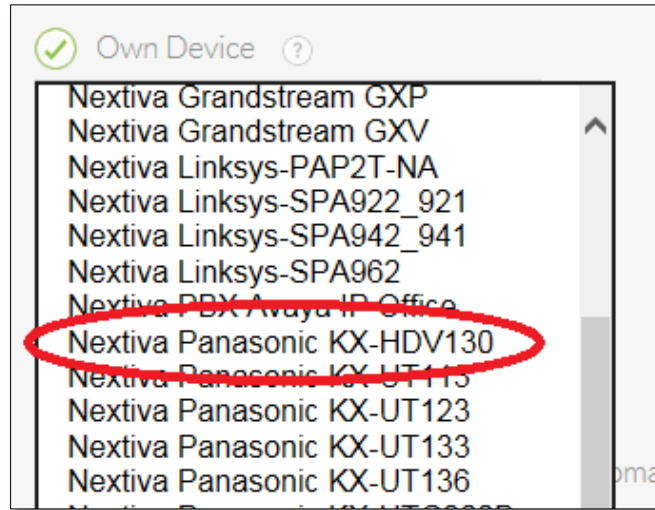

Figure 3-3: Select Model

8. Enter the MAC address in the **MAC Address** text box (Figure 3-4).
9. Click the green **Generate** button under both the Authentication Name and Authentication Password text boxes.

The image shows a form for generating authentication details. It includes the following fields and controls:

- * MAC Address**: Text box containing '080023BF61A6'.
- SIP Username**: Text box containing '8392792467'.
- Domain**: Text box containing 'prod.voipdnsservers.com'.
- Authentication Name**: Text box containing '4616836871'.
- Change Password**: Checked checkbox.
- Authentication Password**: Text box containing '7886968233'.
- Generate**: Two green buttons, one under the Authentication Name field and one under the Authentication Password field.
- Cancel**: A white button at the bottom right.
- Save & Continue**: A green button at the bottom right.

Figure 3-4: Generate Authentication Details

- Click **Save & Continue**. A pop-up message appears confirming that the transaction has been processed (Figure 3-5).

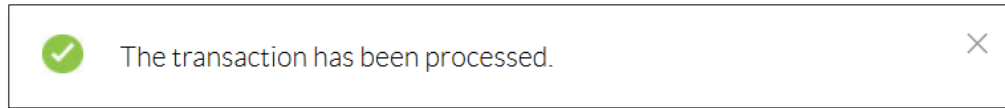

Figure 3-5: Confirmation Message

Checking the Firmware

Before attempting to provision a Panasonic KX-HDV130 phone using the instructions below, make sure that the phone is on firmware version 2.040 or higher. If it is on an older version of the firmware, the phone may fail to register or be unable to make/receive calls.

- From the main screen of the phone, select **Menu** → **Basic Settings** → **Other Option** → **Embedded Web** → **On**. The phone will beep, indicating Embedded Web is now on.
- Press the **Back** softkey (left softkey) twice to go back to the main menu.
- Select **System Settings** → **Status** → **IPv4 Settings** → **IP Address**. Record the IP Address that appears on the screen.
- Use your **web browser** to navigate to the IP Address of the phone (Figure 3-17).

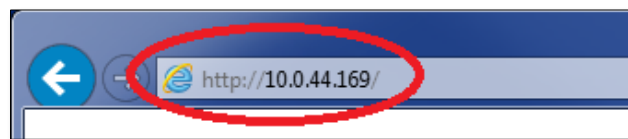

Figure 3-17: Navigate to the IP Address

- Enter **admin** as the username and **adminpass** as the password (Figure 3-18).

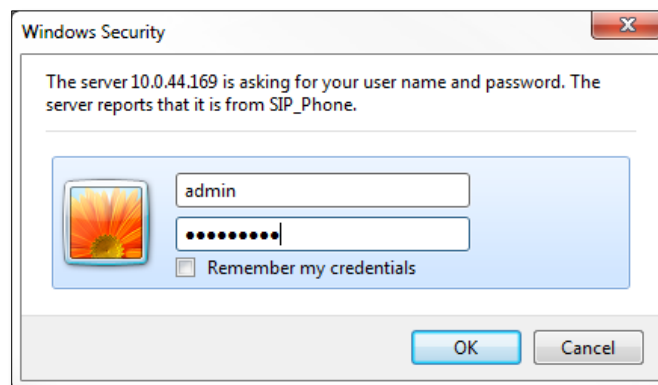
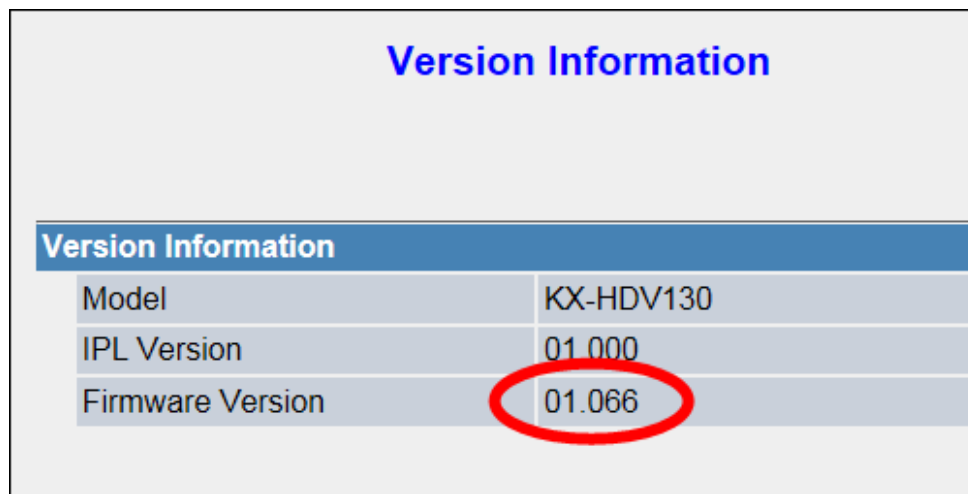

Figure 3-18: Log in to the Phone Interface

6. Verify the firmware version that displays on the screen is version **2.040 or higher**. If it is, skip to the section titled **Entering the Provisioning Server**.

If the firmware version is lower than 2.040, follow the instructions below to upgrade the firmware (Figure 3-19).



Version Information	
Model	KX-HDV130
IPL Version	01.000
Firmware Version	01.066

Figure 3-19: Check the Firmware Version

7. Click the **Maintenance** tab at the top of the screen (Figure 3-20).



Figure 3-20: Maintenance Tab

8. Click **Firmware Maintenance** on the left side of the screen (Figure 3-21).

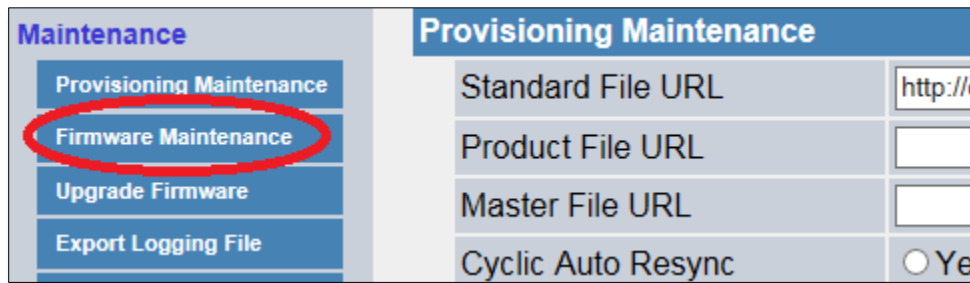

Figure 3-21: Firmware Maintenance

9. Enter http://dm.nextiva.com:80/dms/Nextiva_Service_Provider/KXHDTV130/firmware02.040.fw in the **Firmware File URL** text box (Figure 3-22).

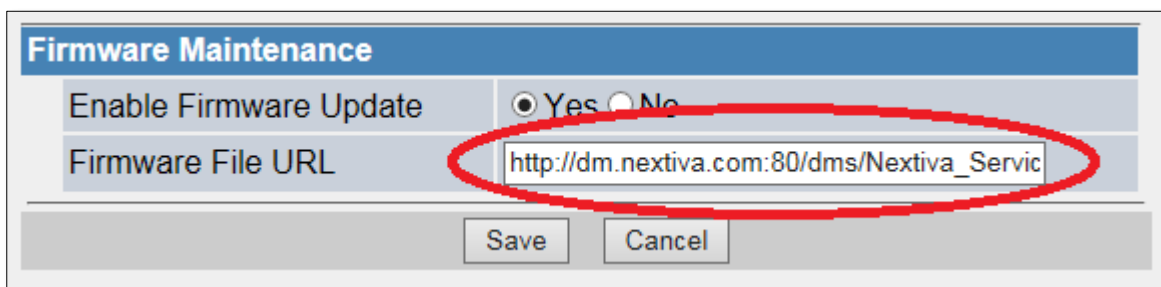

Figure 3-22: Enter Firmware Address

10. Click the **Save** button at the bottom of the screen. The phone should reboot. If it does not, manually reboot the phone by temporarily disconnecting the AC adapter from the back of the phone and reconnecting it (Figure 3-23).

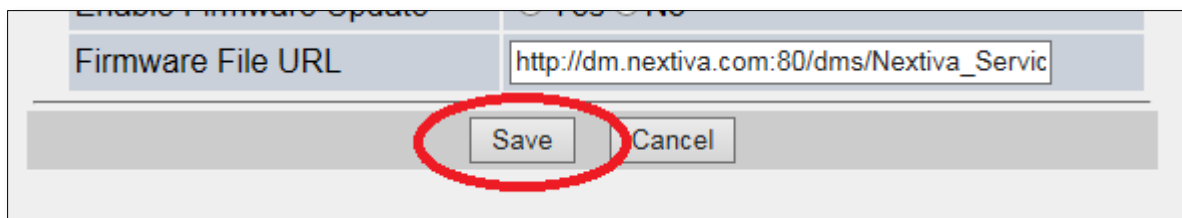

Figure 3-23: Save Firmware Changes

11. The firmware on your Panasonic KX-HDV130 has now been updated.

NOTE: When this phone is power cycled for any reason, the embedded web feature is turned off and must be turned back on.

Entering the Provisioning Server

If the Panasonic KX-HDV130 phone was purchased from Nextiva, then the phone should arrive with the provisioning address already programmed into the phone. If the phone was purchased from a third party, or if the phone required a factory reset, you will need to manually enter the provisioning address in to the phone. Follow the instructions below to do this.

1. From the main screen, select **Menu → Basic Settings → Other Option → Embedded Web → On**. The phone will beep, indicating Embedded Web is now on.
2. Press the **Back** softkey (left softkey) twice to go back to the main menu.
3. Select **System Settings → Status → IPv4 Settings → IP Address**. Record the IP Address that appears on the screen.
4. Use your **web browser** to navigate to the IP Address of the phone (*Figure 3-24*).



Figure 3-24: Navigate to the IP Address

5. Enter **admin** as the username and **adminpass** as the password (*Figure 3-25*).

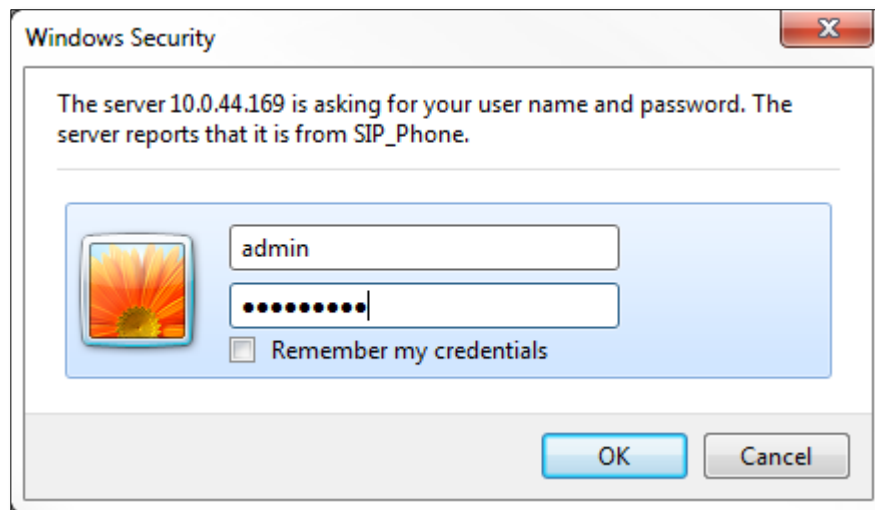

Figure 3-25: Log in to the Phone Interface

- Click the **Maintenance** tab at the top of the screen (Figure 3-26).



Figure 3-26: Maintenance Tab

- Enter http://dm.nextiva.com:80/dms/Nextiva_Service_Provider/KXHDTV130/HDV130-{mac}.cfg in the **Standard File URL** text box (Figure 3-27).

A screenshot of the "Provisioning Maintenance" configuration page. It features a table with four rows: "Standard File URL", "Product File URL", "Master File URL", and "Cyclic Auto Resync". The "Standard File URL" field contains the text "http://dm.nextiva.com:80/dms/Nextiva_Servic" and is circled in red. The "Cyclic Auto Resync" field has radio buttons for "Yes" and "No", with "No" selected.

Figure 3-27: Standard File URL

8. Click the **Save** button. The phone should reboot. If it does not, manually reboot the phone by temporarily disconnecting the AC adapter from the back of the phone and reconnecting it (Figure 3-28).

Resync Interval	<input type="text" value="10080"/>	minutes [1-40320]
Time Resync	<input type="text"/>	[00:00-23:59, NULL: Disable]
Header Value for Resync Event	<input type="text" value="check-sync"/>	
<input type="button" value="Save"/> <input type="button" value="Cancel"/>		

Figure 3-28: Save Provisioning Changes

The phone should then provision and register. If the phone displays **Registering...** on the screen after boot up, manually reboot the phone a second time.

Additional Setup Options

Correcting the Time

If the Panasonic KX-HDV130 does not display the correct time, first check the time zone assigned to the user in the NextOS 3.0 Beta portal. If the time zone is correct, you need to adjust the time zone settings in the phone itself. Follow the instructions below to do this.

1. From the main screen, select **Menu** → **Basic Settings** → **Other Option** → **Embedded Web** → **On**. The phone will beep, indicating Embedded Web is now on.
2. Press the **Back** softkey (left softkey) twice to go back to the main menu.
3. Select **System Settings** → **Status** → **IPv4 Settings** → **IP Address**. Record the IP Address that appears on the screen.
4. Use your **web browser** to navigate to the IP Address of the phone (*Figure 4-1*).

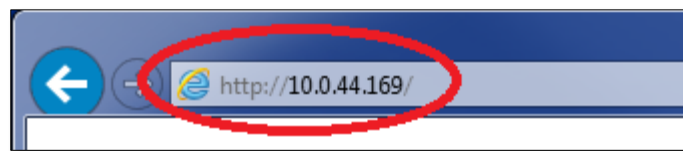

Figure 4-1: Navigate to the IP Address

5. Enter **admin** as the username and **adminpass** as the password (*Figure 4-2*).

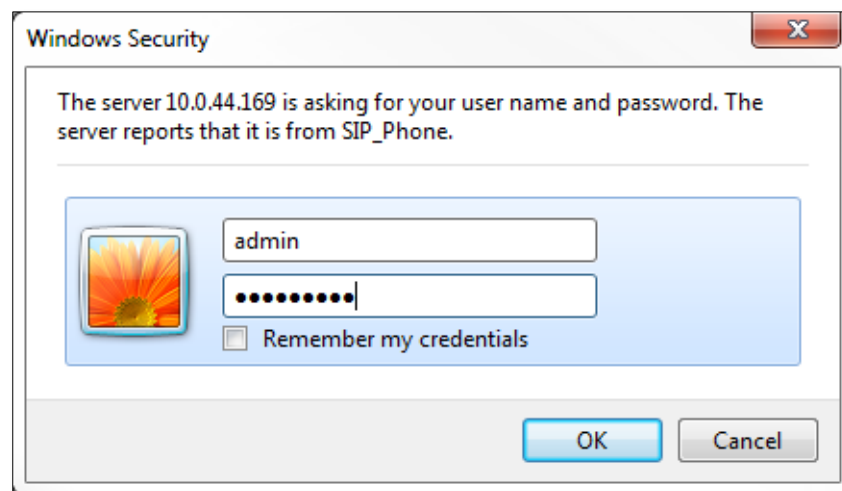

Figure 4-2: Log in to the Phone Interface

- Click the **System** tab at the top of the screen (Figure 4-3).



Figure 4-3: System Tab

- Click **Time Adjust Settings** on the left side of the screen (Figure 4-4).



Figure 4-4: Time Adjust Settings

- Select the correct time zone in the **Time Zone** drop-down list (Figure 4-5).

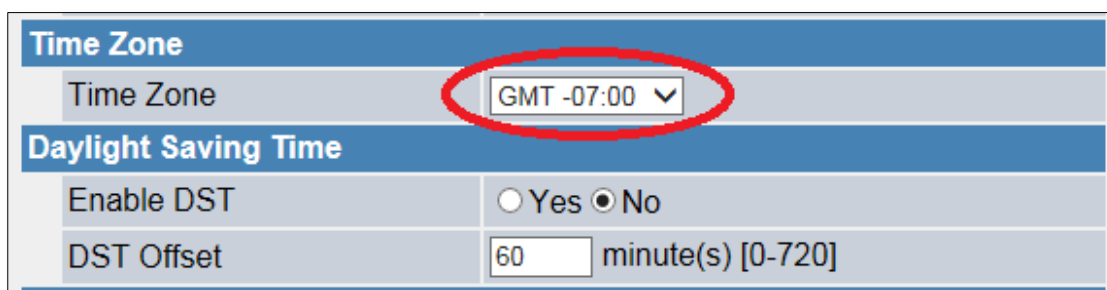
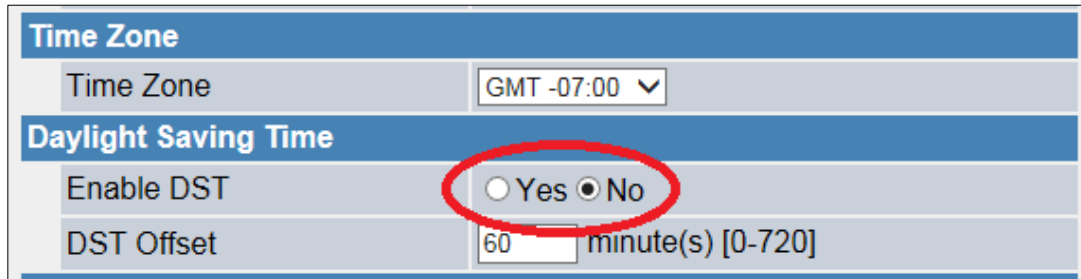

Figure 4-5: Time Zone Drop-Down List

9. If necessary, disable daylight savings time by selecting the **No** option to the right of **Enable DST** (Figure 4-6).



Time Zone	
Time Zone	GMT -07:00 ▼
Daylight Saving Time	
Enable DST	<input type="radio"/> Yes <input checked="" type="radio"/> No
DST Offset	60 minute(s) [0-720]

Figure 4-6: Enable DST options

10. Click the **Save** button at the bottom of the screen. The time should adjust instantly on the phone (Figure 4-7).

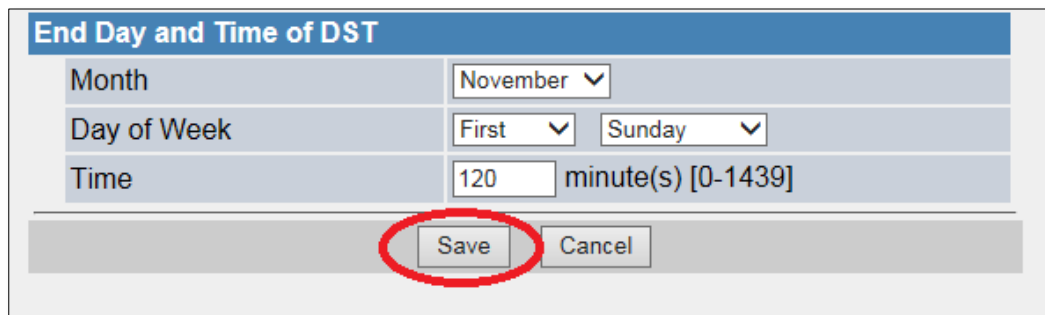

End Day and Time of DST		
Month	November ▼	
Day of Week	First ▼	Sunday ▼
Time	120 minute(s) [0-1439]	
<input checked="" type="button" value="Save"/> <input type="button" value="Cancel"/>		

Figure 4-7: Save Time Settings

Line Mirroring

Line mirroring is not needed to accept a second incoming call, but it is needed to make a second outbound call. The preferred method to set up line mirroring is to use custom tags, which requires the assistance of a Nextiva Technician.

Busy Lamp Field (BLF)

Busy Lamp Field (BLF) is a service that allows a user to see/monitor (from their phone) whether another user is on the phone or not. This feature is commonly used by administrative assistants for ease of call transfer, and by call center managers to assist in monitoring their employees. The Panasonic KX-HDV130 is a two-line phone, so if you do not want to use the phone's second line for line mirroring (see *Line Mirroring* above), both line keys can be used to update the status of the Busy Lamp Field. If you would like to set up BLF on your phone, please contact Nextiva Support.

Directories

Remote directories, such as Custom Contact Directories and the group Common Phone List, are currently not supported on the Panasonic KX-HDV130 phone.

Speed Dials

While it is possible to set up speed dials through the menu on the Panasonic KX-HDV130, setting up speed dials using Nextiva's included speed dial features is preferred. Doing so will ensure your speed dials are not lost in the event of hardware failure. Follow the instructions below to set up Speed Dial, which will allow the user to dial frequently called numbers using 00 through 99 on their keypad.

From the Panasonic KX-HDV130 phone:

1. Go **off-hook**.
2. Dial ***74** from the phone.
3. After the beeps, enter the number to be used for the speed dial, then the phone number or extension, followed by **#**.

EXAMPLE: To set up the number 3 as a speed dial to 4805551234: enter 3 enter the phone number or extension, then # (Example: 34805551234#).

4. Go **on-hook**.

NOTE: In this guide **off-hook** is used to describe when a phone is in use, or has a dial tone before a call is made. **On-hook** describes when a phone is idle.

For instructions on how to use Speed Dial, see the section titled "Using Speed Dials" in Basic Phone Usage

From the NextOS 3.0 Beta portal:

1. For Administrators, log in to the NextOS 3.0 Beta portal by visiting www.nextiva.com and clicking on the customer Login found at the top right.
2. Log in to the NextOS 3.0 Beta portal with your login credentials.

- From the main dashboard, click **Manage** in the **Users** tile (Figure 4-8).

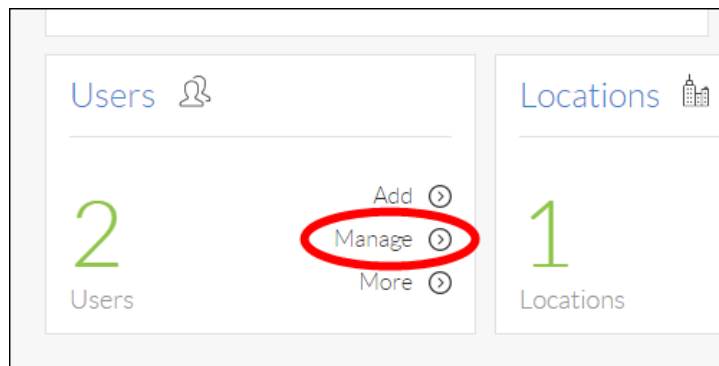

Figure 4-8: Manage Users

- Hover your cursor over the user for whom you want to set up speed dials, and click the **pencil icon** to the right (Figure 4-9).

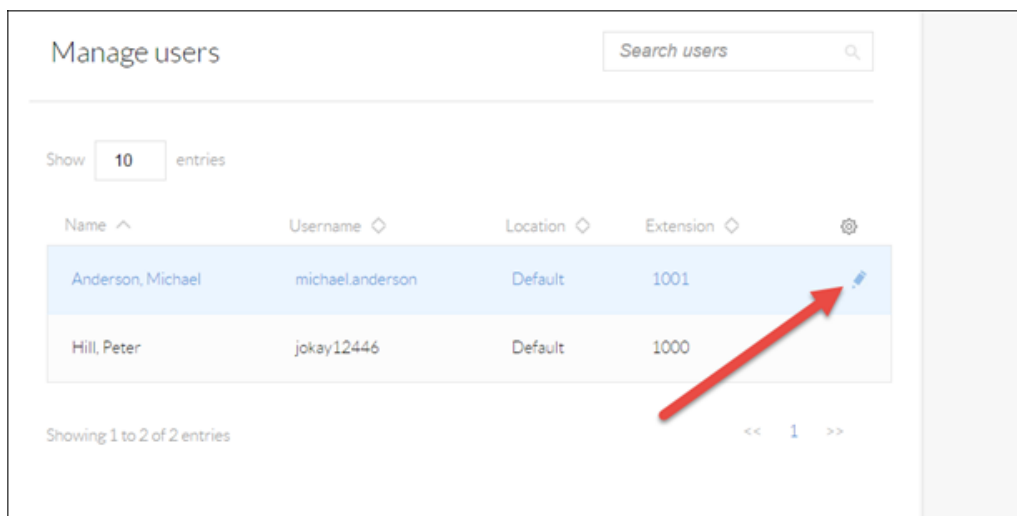

Figure 4-9: Edit User

5. Scroll down and select the **Routing** section (Figure 4-10).

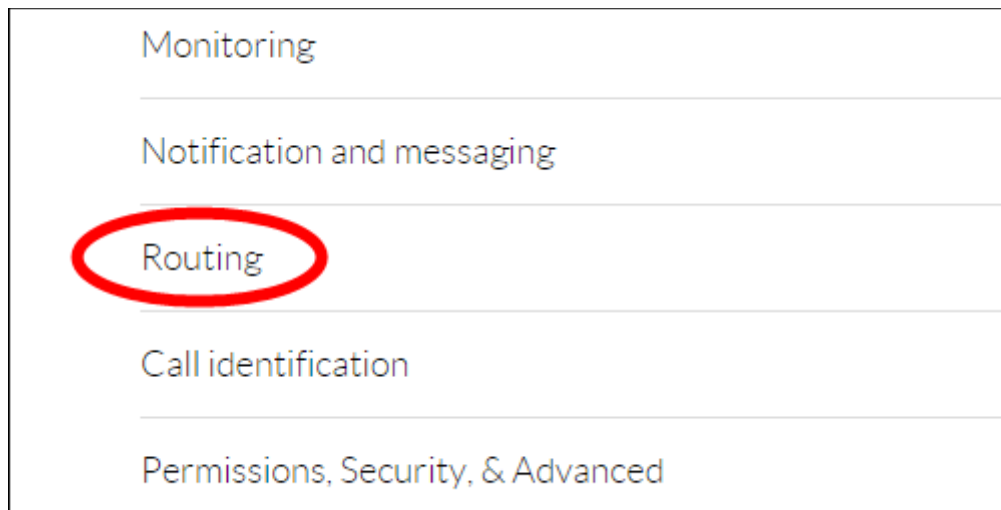

Figure 4-10: Routing Section

6. Click the **pencil icon** to the right of Speed dial (Figure 4-11).

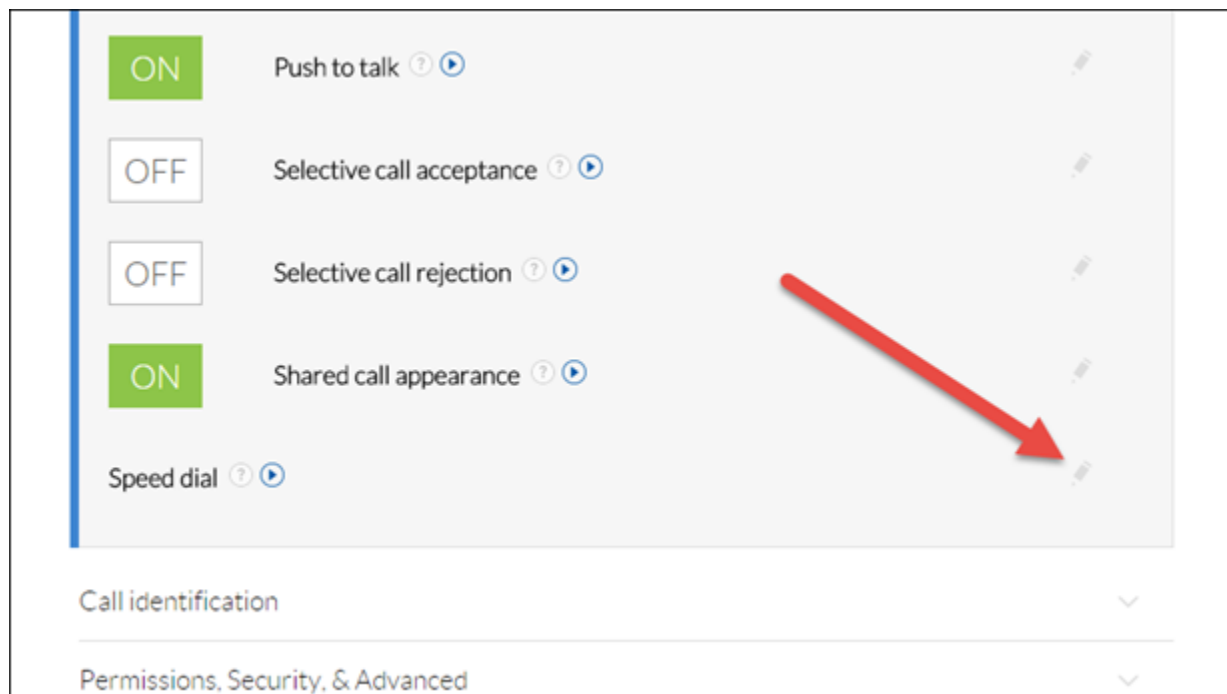

Figure 4-11: Speed Dial

7. Click the **plus sign** at the bottom-right (*Figure 4-12*).

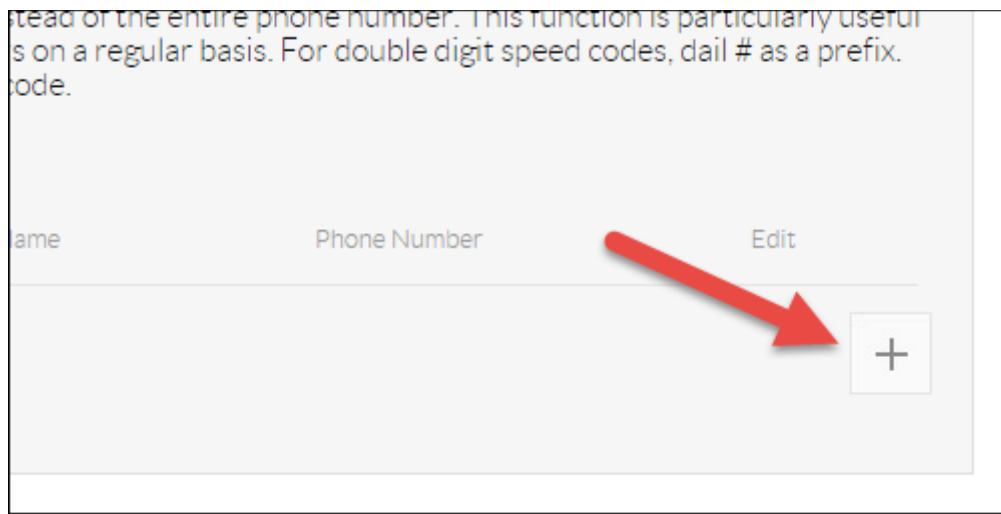

Figure 4-12: Add Speed Dial

8. Select the speed dial number from the **Option** drop-down list (*Figure 4-13*).

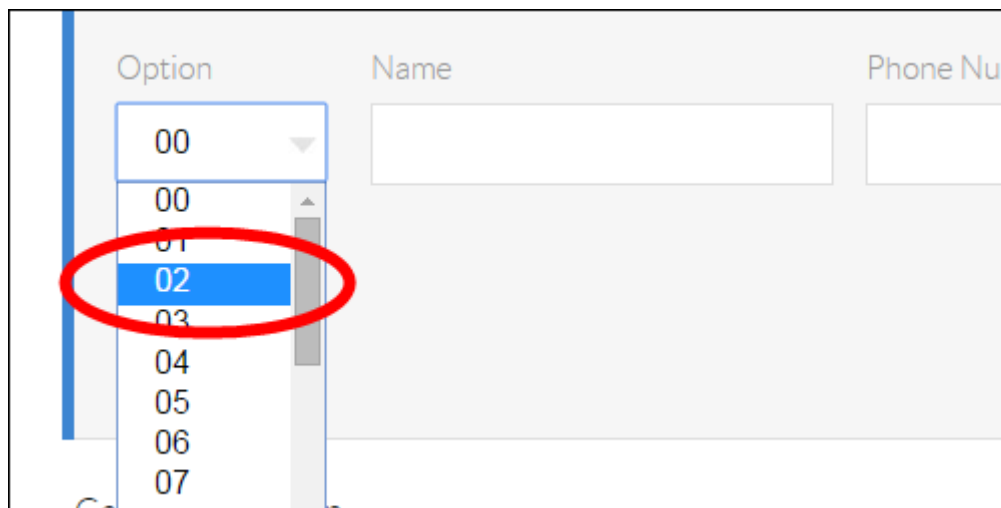

Figure 4-13: Speed Dial Number

9. Enter a descriptive name for the speed dial in the **Name** text box, and then enter the phone number or extension in the **Phone Number** text box. Please note that special characters or spaces are not supported for the speed dial descriptive name (*Figure 4-14*).

For single digit codes, just dial the code.

Option	Name	Phone Number	Edit
02	JohnCell	4805551234	

Call identification

Figure 4-14: Description and Phone Number

10. Click the green **Save** button at the bottom-right of the Speed dial menu. A pop-up message appears stating that the speed dial 100 settings have been saved successfully.

For instructions on how to use Speed Dial, see the section titled “Using Speed Dials” in Basic Phone Usage.

Automatic Call Distribution (ACD) States

The Panasonic KX-HDV130 supports phone integration with Nextiva Call Center Pro and Nextiva Call Center Enterprise’s ACD states, allowing agents to go available and sign out of a call center from their phone’s interface. To set up this feature, contact Nextiva Support.

NOTE: If you will be setting up ACD capabilities on the Panasonic KX-HDV130 phone, you will not be able to set up line mirroring or BLF. Both of the programmable keys on the right side of the phone will be dedicated to ACD features and not available for other use.

Basic Phone Usage

Instructions on basic phone usage, including how to make and receive calls, transfer calls, initiate a conference call, check voicemail, etc. are outlined below for Panasonic KX-HDV130 users.

Making a Call

Using the Handset:

1. Go **off-hook**.
2. Dial the phone number or extension of the party you want to call, and press the **Call** softkey (middle softkey).

NOTE: If you dial the full 10 digit phone number of the party you want to call, the Panasonic KX-HDV130 will automatically start dialing, so pressing the Call softkey will not be necessary.

3. When finished with the call, go **on-hook** to disconnect the call.

Using the Speakerphone:

1. Press the **SP-PHONE** button on the bottom-right of the phone.
2. Dial the phone number or extension of the party you want to call, and press the **Call** softkey (middle softkey).

NOTE: If you dial the full 10 digit phone number of the party you want to call, the Panasonic KX-HDV130 will automatically start dialing, so pressing the Call softkey will not be necessary.

3. When finished with the call, press the **SP-PHONE** button on the bottom-right of the phone to disconnect the call.

Using a Headset (optional):

1. Press the **HEADSET** button on the bottom-left of the phone.
2. Dial the phone number or extension of the party you want to call, and press the **Call** softkey (middle softkey).

NOTE: If you dial the full 10 digit phone number of the party you want to call, the Panasonic KX-HDV130 will automatically start dialing, so pressing the Call softkey will not be necessary.

3. When finished with the call, press the **HEADSET** button on the bottom-right of the phone to disconnect the call.

Making a Second Call

Before attempting to make a second call, you must first contact Nextiva Support to set up line mirroring as per the section titled “Line Mirroring” in Additional Setup.

Using the Handset:

1. While on a call, press the **Line 2/P2** button on the right side of the phone. The first party is automatically put on hold.
2. Dial the phone number or extension of the party you want to call, and press the **Call** softkey (middle softkey).

NOTE: Pressing the **HOLD/MESSAGE** button allows you to switch back and forth between the two calls.

3. When finished, go **on-hook**, then go **off-hook** to disconnect the call with the party you are speaking to and return to the call with the other party.

Using the Speakerphone:

1. While on a call with one call, press the **Line 2/P2** button on the right side of the phone. The first party is automatically put on hold.
2. Dial the phone number or extension of the party you want to call, and press the **Call** softkey (middle softkey).

NOTE: Pressing the **HOLD/MESSAGE** button allows you to switch back and forth between the two calls.

3. When finished with one call, press the **SP-PHONE** button on the bottom-right of the phone to disconnect the call with the party you are speaking to. Press the **SP-PHONE** button again to return to the call with the other party.

Using a Headset (optional):

1. While on a call, press the **Line 2/P2** button on the right side of the phone. The first party is automatically put on hold.
2. Dial the phone number or extension of the party you want to call, and press the **Call** softkey (middle softkey).

NOTE: Pressing the **HOLD/MESSAGE** button allows you to switch back and forth between the two calls.

3. When finished with one call, press the **HEADSET** button on the bottom-right of the phone to disconnect the call with the party you are speaking to. Press the **HEADSET** button again to return to the call with the other party.

Accepting a Call

Using the Handset:

1. While the phone is ringing, go **off-hook**.

Using the Speakerphone:

1. While the phone is ringing, press the **SP-PHONE** button on the bottom-right of the phone.

Using a Headset (optional):

1. While the phone is ringing, press the **HEADSET** button on the bottom-left of the phone.

Accepting a Second Call

Using the Handset:

1. When you hear the call waiting tone through the handset, press the **Answer** softkey (left softkey) on the phone. The first call is put on hold, and you are connected to the second call through the handset.
2. To return to the call with the first party, press the **HOLD/MESSAGE** button on the left side of the phone. Press the **HOLD/MESSAGE** button again to return to the second call.
3. When finished speaking to the second party, go **on-hook**, then go **off-hook** to return to the call with the first party.

Using the Speakerphone:

1. When you see the second incoming call on the screen, press the **Answer** softkey (left softkey) on the phone. The first call is put on hold, and you are connected to the second call through the speakerphone.
2. To return to the call with the first party, press the **HOLD/MESSAGE** button on the left side of the phone. Press the **HOLD/MESSAGE** button again to return to the second call.
3. When finished speaking to the second party, press the **SP-PHONE** button on the bottom-right of the phone, then press the **SP-PHONE** button again to return to the call with the first party.

Using a Headset (optional):

1. When you see the second incoming call on the screen, press the **Answer** softkey (left softkey) on the phone. The first call is put on hold, and you are connected to the second call through the headset.
2. To return to the call with the first party, press the **HOLD/MESSAGE** button on the left side of the phone. Press the **HOLD/MESSAGE** button again to return to the second call.
3. When finished speaking to the second party, press the **HEADSET** button on the left side of the phone, then press the **HEADSET** button again to return to the call with the first party.

Terminating a Call

Using the Handset:

1. While on a call, go **on-hook**.

Using the Speakerphone:

1. While on a call, press the **SP-PHONE** button on the bottom-right of the phone.

Using a Headset (optional):

1. While on a call, press the **HEADSET** button on the bottom-left of the phone.

Transferring a Call

There are two types of call transfers—a warm transfer (attended), and a blind transfer (unattended). A warm transfer occurs when you speak to the party you are transferring the call to before you transfer the call to them. With a cold transfer, you do not speak to the receiving party.

Warm Transferring:

1. While on a call, press the **TRANSFER** button toward the bottom-right of the phone. The party you were speaking to is put on hold, and you hear a dial tone.
2. **Dial** the phone number or extension of the party you want to transfer the call to, and press the **Call** softkey (middle softkey). Wait for the other party to answer so you can speak to them before transferring the call.

NOTE: To cancel the transfer and return to the original party, press the **Cancel** softkey (right softkey) once if you have not already started dialing, and twice if you have.

3. When the other party is ready to accept the call, press the **TRANSFER** button toward the bottom-right of the phone again to transfer the call to them.

Cold Transferring:

1. While on a call, press the **Blind** softkey (right softkey).
2. **Dial** the phone number or extension of the party you want to transfer the call to, and press the **Call** softkey (middle softkey).

NOTE: To cancel the transfer and return to the original party, press the **Cancel** softkey (right softkey) once if you have not already started dialing, and twice if you have.

Conferencing

1. While on a call, press the **CONF** button toward the bottom-right of the phone.
2. **Dial** the phone number or extension of the party you want to add to the conversation, and press the **Call** softkey. Wait for the other party to answer so you can speak to them before conferencing in the original party.
3. Press the **CONF** button toward the bottom-right of the phone again to add the original party to the conversation.

Checking Voicemail

When you have a new voicemail message, the Panasonic KX-HDV130 phone displays **Voice MSG:XXX** on the screen (where XXX is the number of the messages), and the message waiting indicator light on the upper-right of the phone **slowly flashes blue**.

Before you can check your voicemail messages, you must set up your voicemail box. This requires changing your voicemail password, and recording your name (i.e. John Smith). Follow the instructions below to complete the initial setup of your voicemail box.

1. While the phone is idle (not on a call), press the **HOLD/MESSAGE** button on the left side of the phone.

NOTE: You must press the HOLD/MESSAGE button before going off-hook, or pressing the SP-PHONE or HEADSET button. If you do not, pressing the HOLD/MESSAGE button will have no effect. To switch to using the handset or a headset, go off-hook or press the HEADSET button.

2. Enter your password when prompted to. The default password is **0000#**.
3. If this is your first time checking your voicemail, follow the prompts to change your password, and record your name.
4. Press **1** to access your voicemail box.
5. Press **1** to listen to your messages.
6. When finished listening to your voicemails, **hang up**, or proceed to the instructions below.

By default, if you do not answer your phone after 3 rings, the call will be forwarded to voicemail, and callers will hear your recorded name followed by a message saying “is not available to take your call, please leave a message after the beep.” If desired, you can set up a longer, more personal greeting after the initial voicemail setup is complete.

Recording a Custom Voicemail Greeting

To set up a custom No Answer greeting, which is the default greeting that plays if you do not answer your phone after 3 rings. Follow the instructions below to do this:

1. While the phone is idle (not on a call), press the **HOLD/MESSAGE** button on the left side of the phone.

NOTE: You must press the HOLD/MESSAGE button before going off-hook, or pressing the SP-PHONE or HEADSET button. If you do not, pressing the HOLD/MESSAGE button will have no effect. To switch to using the handset or a headset, go off-hook or press the HEADSET button.

2. Enter your password when prompted to.
3. Press **1** to access your voicemail box.
4. Press **3** to record a No Answer greeting.
5. Press **1** to record a new No Answer greeting, and press **#** when you are done speaking.
6. When finished recording your No Answer greeting, **hang up** the call.

Directories

Remote directories, such as Custom Contact Directories and the group Common Phone List, are currently not supported on the Panasonic KX-HDV130 phone.

Call Lists

The Panasonic KX-HDV130 does not store missed calls, incoming calls, or outgoing calls locally on the phone. Because of this, the phone can be safely rebooted without losing your call logs.

Missed Calls:

When there is a missed call on the phone, the phone screen displays **Missed Call** and the message waiting light **slowly flashes blue** if the caller left a voicemail message.

1. Press the **Call Log** softkey (right softkey) on the phone, and then select **Missed Call** from the menu. The last missed call displays on the screen, as well as the date and time of the call.
2. Use the up (↑) and down (↓) arrow keys to scroll through the list of missed calls (if more than one).
3. Go **off-hook** to call out to the number using the handset, or press the **SP-PHONE** or **HEADSET** buttons to call out using the speakerphone or headset, respectively.

NOTE: After you have checked your missed calls, the missed calls screen no longer displays the missed calls, but this information can still be found in the Incoming Calls screen (see below).

Incoming Calls:

1. Press the **Call Log** softkey (right softkey) on the phone, and then select **Incoming Log** from the menu. The last incoming call displays on the screen, as well as the date and time of the call.
2. Use the up (↑) and down (↓) arrow keys to scroll through the list of incoming calls (if more than one).
3. Go **off-hook** to call out to the number using the handset, or press the **SP-PHONE** or **HEADSET** buttons to call out using the speakerphone or headset, respectively.

Outgoing Calls:

1. Press the **Call Log** softkey (right softkey) on the phone, and then select **Outgoing Log** from the menu. The last Outgoing call displays on the screen, as well as the date and time of the call.
2. Use the up (↑) and down (↓) arrow keys to scroll through the list of outgoing calls (if more than one).
3. Go **off-hook** to call out to the number using the handset, or press the **SP-PHONE** or **HEADSET** buttons to call out using the speakerphone or headset, respectively.

Changing ACD States

In order for an agent to change their ACD state for the queues in the call center they are assigned to from the Panasonic KX-HDV130 phone, ACD functionality needs to be enabled on the phone. To do this, see the Automatic Call Distribution (ACD) section above.

Signing In

To sign in to a queue, press the **LINE 1/P1** button on the right side of the phone until both the LINE 1/P1 and LINE 2/P2 status lights turn **off**. This indicates you are available and that any calls into the queue could potentially route to your phone.

Going Unavailable

Changing your ACD state to Unavailable (going unavailable) is typically done when taking a break or when you are away from your phone. To do this, press the **LINE 2/P2** button on the right side of the phone once. The status light above the LINE 2/P2 button turns solid **red**. This can be done before or after the current call has ended.

NOTE: At this time, Nextiva does not support the use of custom unavailable codes.

Going Available

When returning to your desk from a break, meeting, etc., you need to change your ACD state to Available (go available) again. To do this, press the **LINE 1/P1** button on the right side of the phone until both the LINE 1/P1 and LINE 2/P2 status lights turn off. This indicates you are available and that any calls into the queue could potentially route to your phone.

Disposition Codes

Disposition Codes are attributes applied to a call to identify marketing promotions or other topics pertaining to a call. If the administrator for your Nextiva account has enabled disposition codes on your call center, you can apply a Disposition Code to a call while the call is still in progress. Follow the instructions below to do this.

1. While on a call, press the **Menu** softkey (middle softkey) at the bottom of the screen.
2. Select **Call Center → Disposition Code** from the menu on the phone.
3. **Enter** the disposition code provided by the administrator for your Nextiva account.
4. Press the **OK** softkey (middle softkey) at the bottom of the screen. You are taken back to the main screen, which shows the caller ID of the incoming call and the running length of the call.

Wrap-Up

Wrap-Up refers to the time after a call ends and before another call is routed to your phone. This is an optional state that can be enabled or disabled for your call center. If the administrator for your Nextiva account has enabled Wrap-Up on the call center, then immediately after the last active call ends on your Panasonic KX-HDV130 phone, your ACD state will change to Wrap-Up. This is indicated by the status light above the LINE 2/P2 button **flashing red**.

From here, you can either wait for the default wrap-up time to expire or you can press the **LINE 1/P1** button on the right side of the phone **twice** to go available immediately.

Signing Out

When going to lunch, leaving for the day, etc., you need to sign out of your queues. To do this, press the **LINE 1/P1** button on the right side of the phone until the status light above the LINE 1/P1 button changes to solid **red**. It does not matter whether there is still a call in progress on the Panasonic KX-HDV130 phone when you do this.

Using Speed Dials

Using the Handset:

1. Go **off-hook**.
2. Enter **#**, then enter the speed dial number on the keypad, and press the **Call** softkey (middle softkey) on the phone.
3. When finished with the call, go **on-hook** to disconnect the call.

Using the Speakerphone:

1. Press the **SP-PHONE** button on the bottom-right of the phone.
2. Enter **#**, then enter the speed dial number on the keypad, and press the **Call** softkey (middle softkey) on the phone.
3. When finished with the call, press the **SP-PHONE** button on the bottom-right of the phone to disconnect the call.

Using a Headset (optional):

1. Press the **HEADSET** button on the bottom-left of the phone.
2. Enter **#**, then enter the speed dial number on the keypad, and press the **Call** softkey (middle softkey) on the phone.
When finished with the call, press the **HEADSET** button on the bottom-left of the phone to disconnect the call.

Additional Features

Do Not Disturb (DND)

The Panasonic KX-HDV130 phone does not have a dedicated DND button. DND can be turned on or off using feature access codes, or through the menu on the phone.

Using Feature Access Codes:

1. Dial ***78** from the phone to turn DND on.

NOTE: After DND is turned on, a DND icon will appear on the screen indicating it is on.

2. To turn DND off, dial ***79** from the phone.

Through the Phone Menu:

1. Press the **Menu** softkey (middle softkey) on the phone.
2. Select **Fwd/DND** from the menu.
3. Select **DND** from the menu.
4. Select **On** from the menu.

NOTE: After DND is turned on, a DND icon will appear on the screen indicating it is on.

5. To turn DND off, follow instructions 1 through 4 above, selecting **Off** instead of On for step 4.

Factory Reset

The Panasonic KX-HDV130 can be factory reset from the device or through the web interface.

From the web interface:

You will need to navigate to the web interface of the Panasonic KX-HDV130, follow the steps below to access the web interface, and then factory reset the phone:

1. From the main screen of your Panasonic KX-HDV130, select **Menu** → **Basic Settings** → **Other Option** → **Embedded Web** → **On**.
2. Press the **Back** softkey (left softkey) twice to go back to the main menu.
3. Select **System Settings** → **Status** → **IPv4 Settings** → **IP Address**. Record the IP Address that appears on the screen.
4. Use your **web browser** to navigate to the IP Address of the phone (*Figure 6-1*).

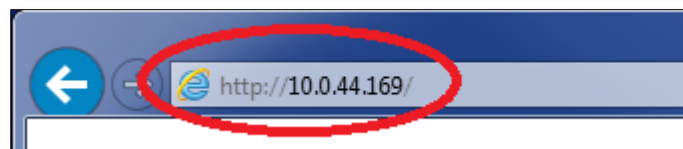

Figure 6-1: Navigate to the IP Address

5. Enter **admin** as the username and **adminpass** as the password (*Figure 6-2*).

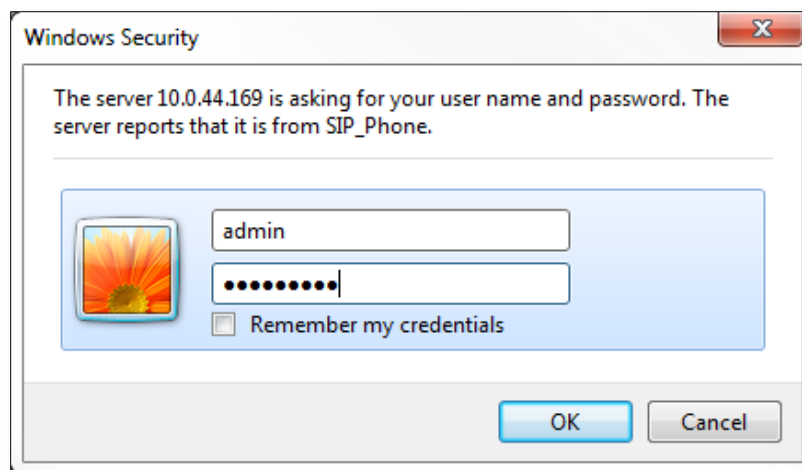

Figure 6-2: Log in to the Phone Interface

- Click the **Maintenance** tab at the top of the screen (Figure 6-3).



Figure 6-3: Maintenance Tab

- Click **Reset to Defaults** on the left side of the screen (Figure 6-4).

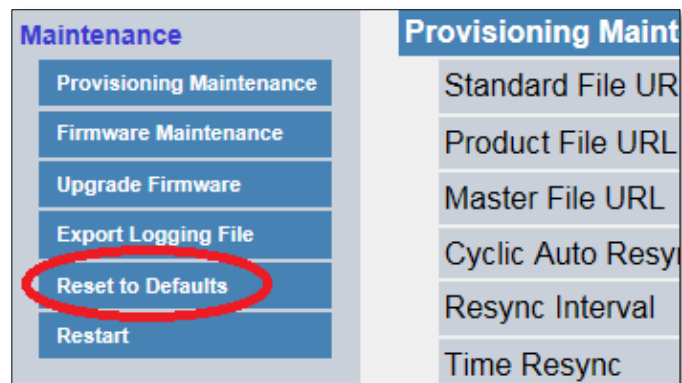

Figure 6-4: Reset to Defaults

- Click the **Reset to Carrier Defaults** button in the middle of the screen (Figure 6-5).

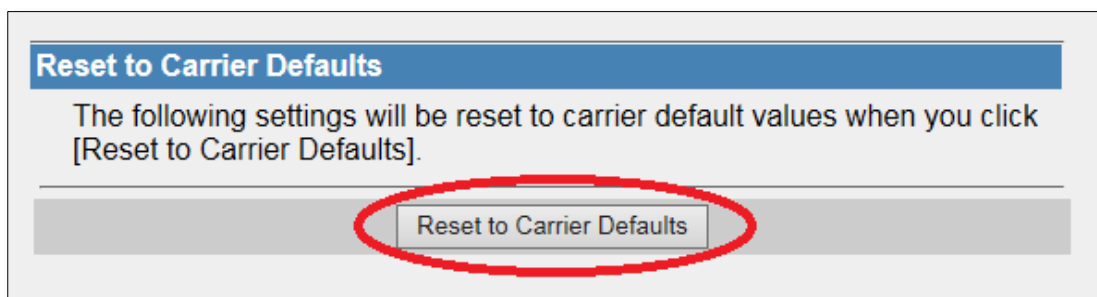

Figure 6-5: Reset to Carrier Defaults

9. Click the **OK** button when the pop-up message appears asking if you are sure you want to reset the settings (*Figure 6-6*).

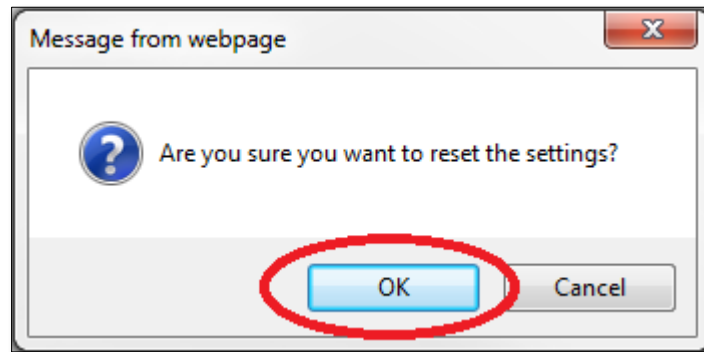

Figure 6-6: Confirm Reset

10. Your Panasonic KX-HDV130 has now completed the factory reset process.

From the Panasonic KX-HDV130:

1. Press the **Menu** softkey (middle softkey) at the bottom of the screen.
2. Select **System Settings** from the menu.
3. Enter **#136** on the keypad.
4. Select **Yes** when asked if you are sure you want to factory reset the phone.